

Sikkim Public Service Commission

Main Written Examination for the Post of Assistant Engineer (Electrical)

PAPER -II

ELECTRICAL ENGINEERING

Afternoon Session

Time Allowed : 3 Hrs.

Maximum Marks : 300

INSTRUCTIONS TO CANDIDATES

Read the following instructions carefully before answering the questions :-

1. **IMMEDIATELY AFTER THE COMMENCEMENT OF THE EXAMINATION, YOU SHOULD CHECK THAT THIS TEST BOOKLET DOES NOT HAVE ANY UNPRINTED OR TORN OR MISSING PAGES OR ITEMS ETC. IF SO, GET IT REPLACED BY A COMPLETE TEST BOOKLET.**
2. Please note that it is the candidate's responsibility to fill in the Roll Number carefully and without any omission or discrepancy at the appropriate places in the **OMR ANSWER SHEET** as well as on **SEPERATE ANSWER SHEET** for MCQ / SUBJECTIVE PAPER. Any omission/discrepancy will render the Answer Sheet liable for rejection.
3. **Use only Black Ball Point Pen to fill the OMR sheet**
4. Do not write anything else on the OMR Answer Sheet except the required information.
5. **This Test Booklet contains 75 items (questions) in MCQ Mode in Part I to be marked in OMR Sheet and Part II - Subjective Questions which has to answered in separate answer sheet provided.**
6. **All items from 1 to 75 carries 2 marks each.**
7. Before you proceed to mark in the Answer Sheet (OMR), you have to fill in some particulars in the Answer Sheet (OMR) as per given instructions.
8. After you have completed filling in all your responses on the Answer Sheet (OMR) and the examination has concluded, you should hand over the Answer Sheet (OMR) and Seperate answer sheet to the Invigilator only . You are permitted to take away with you the Test Booklet.
9. **Marking Scheme**
THERE WILL BE NEGATIVE MARKING FOR WRONG ANSWERS MARKED BY A CANDI DATE IN THE OBJECTIVE TYPE QUESTION PAPERS.
 - (i) There are four alternatives for the answer to every question. For each question for which a wrong answer has been given by the candidate, one-third of the marks assigned to that question will be deducted as penalty.
 - (ii) If a candidate gives more than one answer, it will be treated as a wrong answer even if one of the given answers happens to be correct and there will be same penalty as above to the question.
 - (iii) If a question is left blank. i.e., no answer is given by the candidate, there will be no penalty for that question.

DO NOT OPEN THIS TEST BOOKLET UNTIL YOU ARE ASKED TO DO SO

1. Choose the correct option out of the alternatives:

GROUP-I

- P. 2nd Order Differential Equation
- Q. Non-Linear Algebraic Equation.
- R. Linear Algebraic Equation
- S. Numerical Integration

GROUP-II

- i. Runge-Kutta Method
- ii. Newton-Raphson Method
- iii. Gauss Elimination
- iv. Simposn's Rule

- a. P-i, Q-iii, R-ii, S-iv
- b. P-i, Q-ii, R-iii, S-iv
- c. P-ii, Q-iv, R-iii, S-i
- d. P-iii, Q-ii, R-iv, S-i

2. The Fourier series for the function $f(x) = \sin^2 x$ is

- a. $\sin x + \sin 2x$
- b. $1 - \cos 2x$
- c. $\sin 2x + \cos 2x$
- d. $0.5 - 0.5 \cos 2x$

3. What is the probability that a divisor of 10^{99} is a multiple of 10^{96} ?

- a. $1/625$
- b. $4/625$
- c. $12/625$
- d. $16/625$.

4. For what values of α and β the following simultaneous equations have an infinite number of solutions?

$$x + y + z = 5; x + 3y + 3z = 9; x + 2y + \alpha z = \beta$$

- a. 3,8
- b. 8,3
- c. 2,7
- d. 7,2

5. A pole of driving point admittance function implies

- a. Zero current for a finite value of driving voltage.
- b. Zero voltage for a finite value of driving current.
- c. An open circuit condition
- d. None of (A), (B) and (C) mentioned in the question.

6. In the circuit shown in the figure. the Thevenin voltage and resistance considering X-Y are:

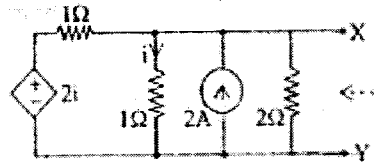

- a. $4/3 V, 2\Omega$
- b. $4V, 2/3\Omega$
- c. $4/3 V, 2/3\Omega$
- d. $4V, 2\Omega$.

7. Which one of the following is a cut-set of the graph shown in the above figure?

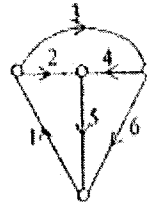

- a. 2,3,4 and 6
- b. 1,3,4 and 5
- c. 1,4,5 and 6
- d. 1,2,3 and 4.

8. A 2-port network is shown in the figure. The parameter h_{21} for this parameter can be given by

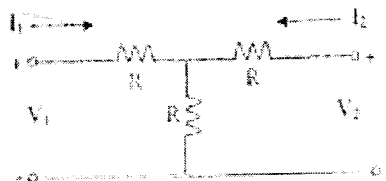

- a. $-1/2$
- b. $+1/2$
- c. $-3/2$
- d. $+3/2$

9. In the circuit shown, V_c is 0 volts at $t=0$ sec. For $t > 0$, the capacitor current $i_c(t)$ where t is in seconds, is given by

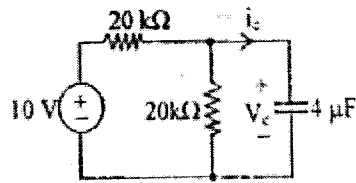

- $0.5 \exp(-25t)$ mA
- $0.25 \exp(-25t)$ mA
- $0.5 \exp(-12.5t)$ mA
- $0.25 \exp(-6.25t)$ mA

10. In a transistor, the forward bias across the base emitter junction is kept constant and reverse bias across the collector base junction is increased. Neglecting the leakage across the collector, base junction and the depletion region generation current. The base current will

- Increase
- Decrease
- Remain constant
- None of these

11. In a n-channel JFET has a pinch-off voltage of $V_0 = -5V$, $V_{DS}(\max) = 20V$ and $g_m = 20mA/V$. The minimum 'ON' resistance is achieved in JFET for

- $V_{GS} = -7V$ and $V_{DS} = 0V$
- $V_{GS} = 0V$ and $V_{DS} = 0V$
- $V_{GS} = 0V$ and $V_{DS} = 20V$
- $V_{GS} = -7V$ and $V_{DS} = 20V$

12. The 6V Zener diode shown in figure has a zero Zener resistance and a knee current of 5mA. The minimum value of R so that the voltage across it does not fall below 6V is

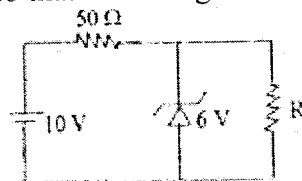

- 1.2 KΩ
- 80 Ω
- 50 Ω
- 0 Ω

13. The load current I_L in the circuit shown is

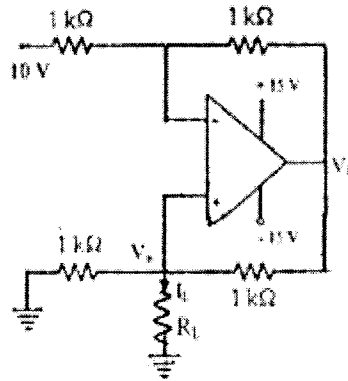

- a. -5 mA
- b. -10 mA
- c. +25 mA
- d. +50 mA

14. The output power of a power amplifier is several times less than its input power. This is possible because

- a. The power amplifier introduces negative resistance
- b. The power amplifier converts a part of dc input power into ac output power.
- c. Positive feedback exists in the circuit
- d. Step up transformer is used in the circuit

15. The sequential circuit shown in the figure is

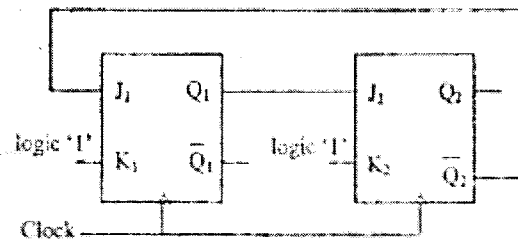

- a. Mod-1 Counter
- b. Mod-2 Counter
- c. Mod-3 Counter
- d. Mod-4 Counter

16. A gate having two inputs (A, B) and one output (Y) is implemented using 4-to-1 multiplexer as shown in Fig. A_1 (MSB) and A_0 are control bits and $I_0 - I_3$ are inputs to multiplexer. The gate is

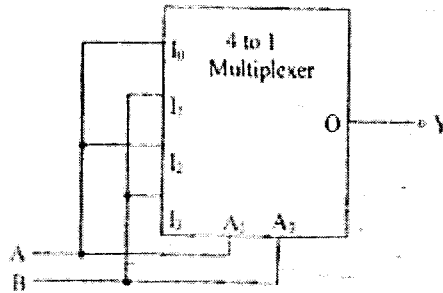

- a. NAND
- b. NOR
- c. XOR
- d. OR

17. The two numbers represented in signed 2's complement form is $P=11101101$ and $Q=11100110$. If Q is subtracted from P, the value obtained in signed 2's complement form is

- a. 10000111
- b. 00000111
- c. 11111001
- d. 111111001

18. The equivalent of the block diagram shown in Fig. is given in

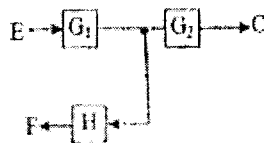

- a.
- b.
- c.
- d.

19. For $M > 1$, the constant M -circles corresponding to the magnitude (M) of the closed loop transfer function of a linear system lie in the G -plane and to the
- Right of the $M=1$ line
 - Left of the $M=1$ line
 - Upper side of the $M=+j1$ line
 - Lower side of $M=-j1$ line
20. The transfer function $G(s) = c(sI - A)^{-1}b$ of the system $\dot{x} = Ax + bu$, $y = cx + du$ has no pole-zero cancellation. The system is
- Controllable and observable
 - Observable but uncontrollable
 - Controllable but unobservable
 - May be any one of a, b or c
21. Let $x(t) \leftrightarrow X(\omega) = \begin{cases} 1, & |\omega| < 1 \\ 0, & |\omega| > 1 \end{cases}$. Consider $y(t) = \frac{d^2x(t)}{dt^2}$. Then value of $\int_{-\infty}^{\infty} |y(t)|^2 dt$ is
- $3/\pi$
 - $2/3$
 - $1/3\pi$
 - $1/6\pi^2$
22. If $y(t) = x(t) * h(t)$, then which of the following statements is correct
- $y(3t) = 3x(3t) * h(3t)$
 - $y(3t) = x(3t) * h(3t)$
 - $y(3t) = \frac{1}{3}x(3t) * h(3t)$
 - $y(3t) = \frac{1}{9}x(3t) * h(3t)$
23. Consider a discrete-time LTI system whose system function is $H(z) = \frac{z}{z-1/2}$; $|z| > 1/2$.
- Then the step response of the system is
- $[2 + (1/2)^n]u(n)$
 - $[2 - (1/2)^n]u(n)$
 - $[1 - (1/2)^n]u(n-1)$
 - $[1 + (1/2)^{n-1}]u(n)$

24. What is the number of turns of wire needed to provide a potentiometer with a resolution of 0.05 percent?
- 200 turns
 - 2000 turns
 - 20 turns
 - 20000 turns
25. Which of the following decides the precision of integrating digital voltmeter?
- reference voltage of analog comparator
 - slope of generated ramp
 - width of generated pulses
 - electronic counter
26. A bridge circuit works at a frequency of 2 kHz. The following can be used as detectors for detection of null conditions in the bridge
- Vibration galvanometers and head phones
 - Headphones and tunable amplifiers
 - Vibration galvanometers and tunable amplifiers
 - Vibration galvanometers, Head phones and tunable amplifiers
27. Guard circuits are used in insulation resistance measurements to
- Increase the range of resistance values measured
 - Reduced the effect of leakage current on measurement
 - Protect against external electric fields
 - Protect against external magnetic fields
28. In a single phase, full converter, if α and β are firing and extraction angle respectively, then the load current is
- Discontinuous if $(\beta - \alpha) < \pi$
 - Discontinuous if $(\beta - \alpha) > \pi$
 - Discontinuous if $(\beta - \alpha) = \pi$
 - continuous if $(\beta - \alpha) < \pi$

29. In the circuit shown in Fig., the maximum current in the main SCR M can be

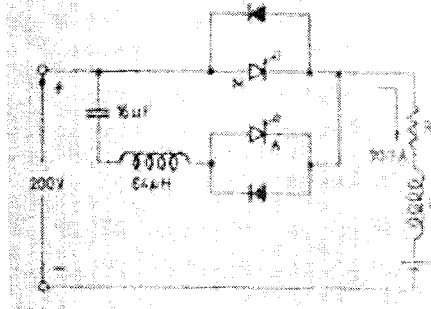

- a. 200 A
- b. 170.7 A
- c. 141.4 A
- d. 70.7 A

30. For a 3-phase bridge inverter in 180° conduction mode, as shown in Fig., the sequence of SCR conduction in first two steps, beginning with initiation of thyristor 1, is

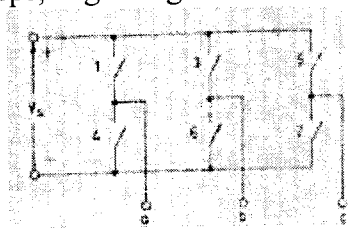

- a. 6,1,2 and 2,3,1
- b. 2,3,1 and 3,4,5
- c. 3,4,5 and 5,6,1
- d. 5,6,1 and 6,1,2

31. In voltage source inverters

- a. Load voltage waveform v_0 depends on load impedance Z , whereas load current waveform i_0 does not depend on Z .
- b. Both v_0 and i_0 depend on Z .
- c. v_0 does not depend on Z whereas i_0 depends on Z .
- d. Both v_0 and i_0 do not depend on Z .

32. In the current-commutated chopper shown in Fig., thyristor T_1 is conducting a load current I_0 . When Thyristor TA is turned on, with capacitor polarity as shown, the capacitor current i_c would flow through

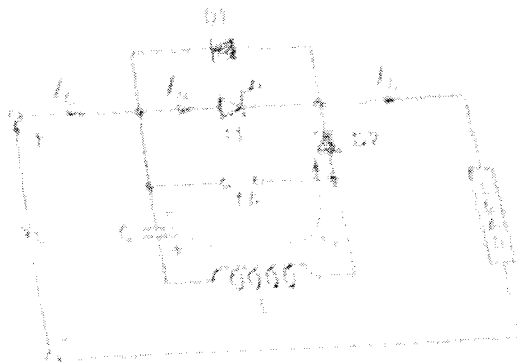

- Diode D_1 because it provides an easy path
- Thyristor T_1 because it is already conducting
- Diode D_1 because thyristor T_1 is unidirectional device and therefore current i_c cannot flow from cathode to anode
- SCR T_1 because diode D_1 is reverse biased by voltage drop across T_1

33. Three-phase to three-phase cycloconverters employing 18 SCR's and 36 SCR's have the same voltage and current ratings for their component thyristors. The ratio of VA rating of 36-SCR-device to that of 18-SCR device is

- $\frac{1}{2}$
- 1
- 2
- 4

34. An initially relaxed 100 mH inductor is switched on at $t = 1s$, to an ideal 2 A dc current source. The voltage across the inductor would be

- Zero
- $0.2 \delta(t) V$
- $0.2 \delta(t - 1) V$
- $0.2 u(t - 1) V$

35. In a single-phase cycloconverter arrangement shown in Fig., the positive direction of currents $i_{p1}, i_{p2}, i_{n1}, i_{n2}$ is as indicated. The turns ratio primary to each secondary is unity. The source current i_s is given by

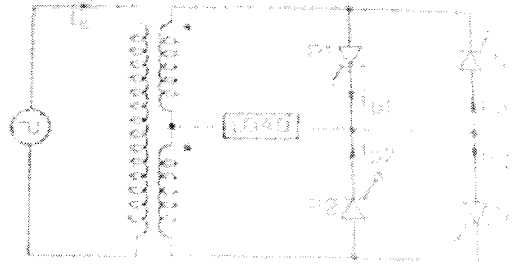

- $i_s = i_{p1} + i_{p2} + i_{n1} + i_{n2}$
- $i_s = i_{p2} - i_{p1} - i_{n1} + i_{n2}$
- $i_s = i_{p1} - i_{p2} - i_{n1} + i_{n2}$
- $i_s = i_{p1} + i_{p2} - i_{n1} - i_{n2}$

36. For protection of parallel feeders fed from one end, the relays required are
- Non-directional relays at the source end and directional relays at the load end
 - Non-directional relays at both ends
 - Directional relays at source end and non-directional relays at load end
 - Directional relays at both ends

37. Consider the problem of relay coordination for the distance relays R_1 and R_2 on adjacent lines of a transmission system. The Zone1 and Zone2 setting for both the relays are indicated on diagram. Which of the following indicates the correct settling time for Zone 2 of relays R_1 and R_2 ?

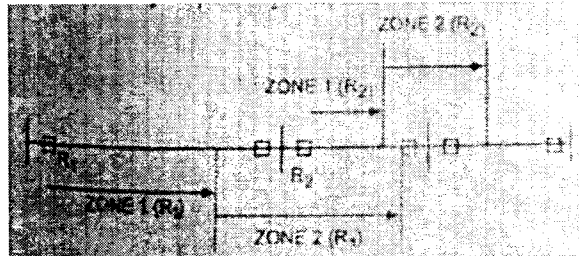

- $TZ2_{R1} = 0.6s, TZ2_{R2} = 0.3s$
- $TZ2_{R1} = 0.3s, TZ2_{R2} = 0.6s$
- $TZ2_{R1} = 0.3s, TZ2_{R2} = 0.3s$
- $TZ2_{R1} = 0.1s, TZ2_{R2} = 0.3s$

38. In the presence of corona, electrostatic coupling and electromagnetic coupling
- Decreases and increases respectively
 - Increases and decreases respectively
 - Increases and remains same respectively
 - Remains same and decreases respectively

39. An initially relaxed 100 mH inductor is switched on at $t = 1s$, to an ideal 2 A dc current source. The voltage across the inductor would be

- a. Zero
- b. $0.2 \delta(t) V$
- c. $0.2 \delta(t - 1) V$
- d. $0.2 u(t - 1) V$

40. The bus bars of each of two alternators of 15% reactance each, are interconnected through tie-bar reactors of 15% each. The equivalent impedance to fault current for a 3-phase fault in any alternator bus-bar will be

- a. 75%
- b. 10%
- c. 11.25%
- d. 15%

41. The following figure shows the single line diagram of a power system with all reactances marked in per unit (pu) on the same base. The system is on no-load when a 3-phase fault occurs at 'F' on the high voltage side of the transformer T_2 . The fault current will be

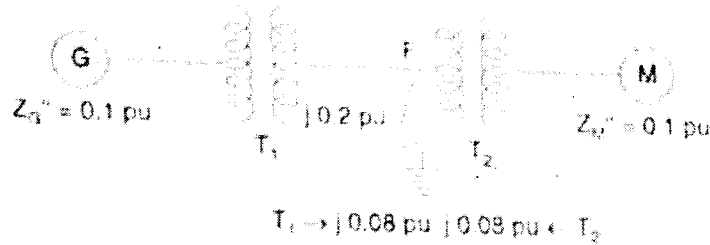

- a. $-j0.8187 pu$
- b. $+j0.8187 pu$
- c. $-j8.1871 pu$
- d. $+j8.1871 pu$

42. An electron moving with a speed u along the positive axis at $y = 0$ enters a region of uniform magnetic field $\vec{B} = B_0$ which exists to the right of y -axis. The electron exits from the region after some time with the speed v at ordinate y , then

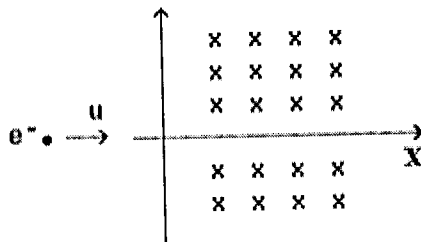

- $v > u, y < 0$
- $v = u, y > 0$
- $v > u, y > 0$
- $v = u, y < 0$

43. Let the function $g: (-\infty, \infty) \rightarrow (-\pi/2, \pi/2)$ be given by $g(u) = 2 \tan^{-1}(e^u) - \pi/2$, then g is

- Even and is strictly increasing in $(0, \infty)$
- Odd and is strictly decreasing in $(-\infty, \infty)$
- Odd and is strictly increasing in $(-\infty, \infty)$
- Neither even nor odd, but strictly increasing in $(-\infty, \infty)$

44. Faraday's law is valid for both open and closed loops. The Lenz's law is valid for

- Only open loop
- Only closed loop
- Both open and closed loop
- None of the above

45. Electromagnetic wave is incident on the interface of two media at an angle θ with the normal directed along y -axis. The direction of the surface current K will be

- Along $+y$ axis
- Along $-y$ axis
- Along $+z$ axis
- Along $-z$ axis

46. In the capacitor – start induction motor shown in figure, the angle α between I_m and I_s is

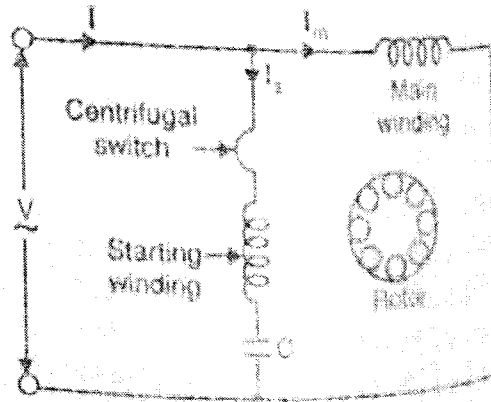

- a. Exactly 90°
- b. About 30°
- c. About 40°
- d. About 75°

47. The armature of a 4-pole shunt motor has a lap winding accommodated in 60 slots, each containing 20 conductors. If the useful flux per pole is 23 mWb, the armature torque developed when the armature current is 50 A will be

- a. 176 N-m
- b. 192 N-m
- c. 256 N-m
- d. 218 N-m

48. The armature of a d.c. machine having 10 poles is rotating at a speed of 10 revolutions per second. The number of hysteresis loops formed per second is

- a. 50
- b. 10
- c. 150
- d. 100

49. Due to the presence of an unpaired electron, free radicals are

- a. Chemically reactive
- b. Chemically inactive
- c. Anions
- d. Cations

50. By putting controller resistance in series with the armature of a d.c. motor, we can obtain speeds
- Above the normal speed only
 - Below the normal speed only
 - Above as well as the below the normal speed
 - None of the above
51. Resistivity of a wire depends on
- length
 - material
 - cross section area
 - none of the above.
52. Resistance of a wire is r ohms. The wire is stretched to double its length, then its resistance in ohms is
- $r / 2$
 - $4 r$
 - $2 r$
 - $r / 4$.
53. The charge on an electron is known to be 1.6×10^{-19} coulomb. In a circuit the current flowing is 1 A. How many electrons will be flowing through the circuit in a second?
- 1.6×10^{19}
 - 1.6×10^{-19}
 - 0.625×10^{19}
 - 0.625×10^{12} .
54. Two 1 kilo ohm, $1/2$ W resistors are connected in series. Their combined resistance value and wattage will be
- $2 \text{ k}\Omega$, $1/2$ W
 - $2 \text{ k}\Omega$, 1 W
 - $2 \text{ k}\Omega$, 2 W
 - $1 \text{ k}\Omega$, $1/2$ W.
55. The hot resistance of a tungsten lamp is about 10 times the cold resistance. Accordingly, cold resistance of a 100 W, 200 V lamp will be
- 4000 ohm
 - 400 ohm
 - 40 ohm
 - 4 ohm.

56. Two aluminium conductors have equal length. The cross-sectional area of one conductor is four times that of the other. If the conductor having smaller cross-sectional area has a resistance of 100 ohms the resistance of other conductor will be

- a. 400 ohms
- b. 100 ohms
- c. 50 ohms
- d. 25 ohms.

57. The electric field strength \vec{E} at far off point P due to a point charge '+q' located due to origin is 100 mV/m. The point charge is now enclosed by perfectly conducting hollow metal sphere with its centre at origin O. The electric field \vec{E} at point P is

- a. Remains unchanged in its magnitude and direction.
- b. Remains unchanged in magnitude and reverse in direction.
- c. would be that due to dipole formed by charge +q at O, and -q induced.
- d. would be zero.

58. Two identical coaxial circular coils carry same current I but in opposite directions. The magnitude of magnetic field \vec{B} at a point on the axis midway between is

- a. Zero
- b. The same as that produced by one coil.
- c. Twice that produced by one coil.
- d. Half of that produced by one coil.

59. Identify which one of the following will not satisfy wave equation.

- a. $50 e^{j(\omega t - 3z)}$.
- b. $\sin [\omega(10z + 5t)]$
- c. $\cos (y^2 + 5t)$
- d. $\sin(x) \cos t$.

60. If $\vec{E} = (a_x + ja_y)$ and $\vec{H} = (k/\omega\mu) (a_y + ja_x) e^{jkz - j\omega t}$, then time averaged Poynting vector is

- a. Null vector.
- b. $(k/\omega\mu) a_z$.
- c. $(2k/\omega\mu) a_z$.
- d. $(k/2\omega\mu) a_z$.

61. A plane wave of wavelength λ is travelling in a direction making an angle 30° with positive x-axis and 90° with positive y-axis. The electric field E of plane wave be represented as-

- a. $\vec{E} = \hat{y} E_0 e^{j(\omega t - \frac{\sqrt{3}}{\lambda}\pi x - \frac{\pi}{\lambda}z)}$
- b. $\vec{E} = \hat{y} E_0 e^{j(\omega t - \frac{\pi}{\lambda}x - \frac{\sqrt{3}}{\lambda}\pi z)}$
- c. $\vec{E} = \hat{y} E_0 e^{j(\omega t + \frac{\sqrt{3}}{\lambda}\pi x + \frac{\pi}{\lambda}z)}$
- d. $\vec{E} = \hat{y} E_0 e^{j(\omega t - \frac{\pi}{\lambda}x + \frac{\sqrt{3}}{\lambda}\pi z)}$

62. Consider following statements regarding complex Poynting vector \vec{P} for power radiated by a point source in an infinite homogeneous and lossless medium. $\text{Re}(\vec{P})$ denotes real part of \vec{P} . 'S' denotes a spherical surface whose centre is at point source and \hat{n} denotes unit surface normal on S. Which of the following statements is true?

- a. $\text{Re}(\vec{P})$ remains constant at any radial distance from the source.
- b. $\text{Re}(\vec{P})$ increases with increasing radial distance from source.
- c. $\oiint \text{Re}(\vec{P}) \cdot \hat{n} ds$ remains constant at any radial distance from source.
- d. $\oiint \text{Re}(\vec{P}) \cdot \hat{n} ds$ decreases with increase in radial distance from source.

63. Low resistance can be accurately measured by

- a. Kelvin bridge
- b. Wheat stone bridge
- c. Wein's bridge
- d. None of the above.

64. A heating element of a hot plate on an electric cooking range draws 12 amperes from 240 V mains. How many kWh of energy will be consumed in one hour and 15 minutes

- a. 1.2
- b. 3.2
- c. 6.0
- d. 7.2.

65. Temperature coefficient of resistance is expressed in terms of
- ohms / ohms °C
 - mhos / ohm °C
 - mhos / °C
 - ohms / °C.
66. If R_t is the resistance of a coil of copper at t °C and R_T is the resistance at T °C and also the resistance temperature coefficient of copper per degree centigrade at 0°C is $1/234.45$, then R_t/R_T
- $(1+t) / (1+T)$
 - $(1+ 234.45t) / (1+234.45 T)$
 - $(234.45 + t) / (234.45 + T)$
 - $(234.45 + t^2) / (234.45 + T^2)$.
67. Two electric bulbs of 100 W, 200 V are put in series and the combination is supplied 100 V. The power consumption of each bulb will be
- 100 / 2 W
 - 100 / 4 W
 - 100 / 8 W
 - 100 / 16 W.
68. For a carbon-composition resistor color coded with green, black, gold and silver stripes from left to right, the resistance and tolerance are
- 50 ohm \pm 10%
 - 5 ohm \pm 5%
 - 5 ohm \pm 10%
 - 0.5 ohm \pm 5%.
69. A resistor with the color coded value of 1000 ohms and \pm 10% tolerance can have an actual resistance between
- 990 ohm and 1010 ohm
 - 900 ohm and 1100 ohm
 - 1000 ohm and 1100 ohm
 - 900 ohm and 1000 ohm.
70. For carbon resistors what is the color for 5?
- Green
 - Black
 - Orange
 - Gray.

71. In a nickel-cadmium-alkali cell the electrolyte is
- Sulphur acid
 - Potassium hydroxide
 - Zinc chloride
 - Ammonium chloride.

72. Match the following:

Column 1

- Copper
- Salt Solution
- Germanium
- Ferronickel alloys

Column 2

- Resistors
- Electrolytic Conductor
- Good Conductor
- Semi-Conductors

- a-(i), b-(ii), c-(iii), d-(iv)
- a-(ii), b-(iii), c-(iv), d-(i)
- a-(iv), b-(i), c-(ii), d-(iii)
- a-(iii), b-(ii) c-(iv), d-(i)

73. Which of the following parallel resistances will have the highest value of equivalent resistance?

- 10 kohm and 25 kohm
- 1 kohm, 2 kohm and 3 kohm
- Two 500 kohm resistors
- Four 40 kohm and two 10 kohm resistors

i.

74. Equivalent Resistance between X and Y is

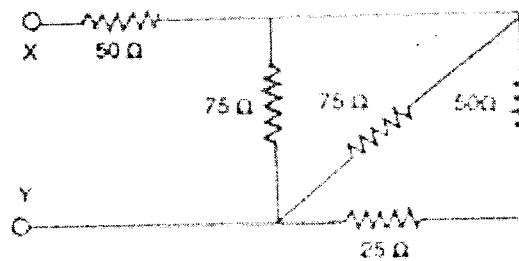

- 50 ohm
- 75 ohm
- 275 ohm
- none of the above.

75. The equivalent resistance of 2N branches in parallel, each having resistance N/2 ohms will be

- 4 ohms
- 2 ohms
- 1 ohm
- 1 / 4 ohm.

Subjective Paper

Consists of 3 sections:-

Section A – 50 Marks

Section B – 50 Marks

Section C – 50 Marks

SECTION A

Attempt any 10 questions

1. A voltage $v = 155.5 \sin 377t + 15.5 \sin 1131t$ (V) is applied to the primary of the transformer having 200 turns and excited by a 60-Hz, 200 V source. Determine
 - a. Maximum value of core flux
 - b. Instantaneous and rms values of core flux

2. What are the basic components of Wind Energy Conversion System? Draw the block diagram of WECS(Wind Energy Conversion System).
Wind at 1 standard atmospheric pressure and 15°C has velocity of 15 m/s, calculate:
 - a. The total power density in the wind stream
 - b. The maximum obtainable power density

3. A 500 kVA, 1 – \emptyset transformer 'A' having 0.015 p.u resistance and 0.05 p.u leakage reactance is to share a load of 750 kVA at 400 V and at 0.8 power factor lagging with another 250 KVA 1 – \emptyset transformer having 0.01 p.u resistance and 0.05 p.u leakage reactance. Their secondary no load emf's are 405 V and 415 V respectively. Find
 - a. Circulating current at no-load
 - b. Current supply by each transformer

4. A 3 – \emptyset , 50 Hz transmission line has R, L and C per phase of 10 Ω , 0.1 H, 0.9 F respectively and delivers a load of 35 MW at 132 KV and 0.8 power factor lagging. Determine
 - a. Efficiency and regulation of the line, using the nominal T-method
 - b. Charging current through the capacitor and sending end current

5. What is meant by accuracy and precision of an instrument?

An LVDT has a maximum core motion of $\pm 1.5 \text{ cm}$ with a linearity of $\pm 0.3 \%$ over that range. The transfer function is 23.8 mV/mm . If used to track work-piece motion from -1.2 to $+1.4 \text{ cm}$, what is the expected output voltage? What is the uncertainty in position determination due to nonlinearity?

6. Draw the circuit diagram of a two input TTL NAND gate and label component values and write the function table.
7. Compute the output $y(t)$ for a continuous time LTI system whose impulse response $h(t)$ and input $x(t)$ are given by $h(t) = e^{-\alpha t}u(t)$, $x(t) = e^{\alpha t}u(-t)$ for $\alpha > 0$.
8. An electric field wave travelling in air is incident normally on a boundary between air and a dielectric having permeability μ_0 and permittivity 4. Prove that one – ninth of the incident power is reflected and eight – ninth of it transmitted into the second medium
9. For the ripple counter shown in Fig. show the complete timing diagram for eight clock pulses, showing the clock, Q_0 and Q_1 waveforms.

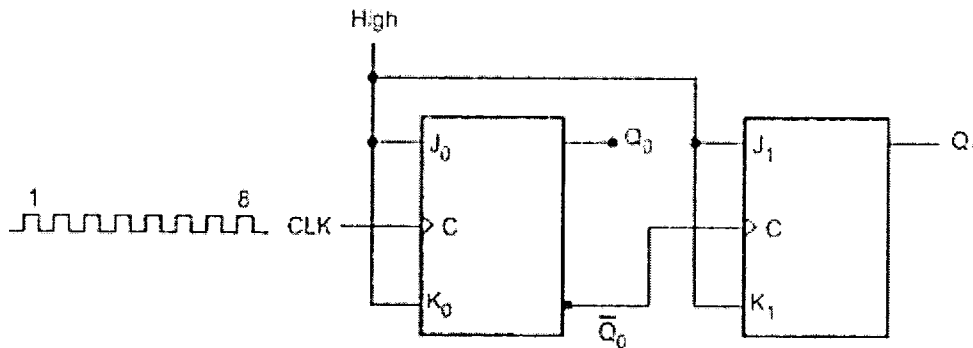

10. The transient response of a second order system when subjected to unit step input is found to have peak overshoot of 16.2 per cent, occurring at a time $5.3 t \pi =$ seconds. If this system is subjected to a sinusoidal input of 1 volt, determine (i) frequency of input at which amplitude of steady state response will have maximum value, (ii) maximum value of steady state output.
11. Draw the diagram of connections of 3 phase Bridge Inverter using six Thyristors. It is based on 120° mode of conduction. Draw the Time diagram showing conduction periods of 6 Thyristors and the phase voltages.

SECTION B

Attempt any 5 questions

12. A full bridge inverter (IGBT) has a switching sequence which produces square wave voltage across a series R-L load. For the instant case the switching frequency is 50 Hz . $V_{dc} = 100\text{ V}$, $R = 10\Omega$ and $L = 25\text{ mH}$. Determine the amplitude of the fourier series terms for load current and power absorbed by the load. Consider only 3rd, 5th and 7th harmonic terms. Compute THD for voltage and current. If the switching sequence is modified to produce quasi square waveform, what changes will be observed in fourier coefficients and THD of voltage waveform and current.

13. Find the value of capacitor C in the circuit shown below, if the voltage across the capacitors is $v_c(t) = 16 - 12e^{-0.6t}$ for $t > 0$ and the switch which was initially open is closed at $t = 0$. The circuit had attained steady state before closing of the switch.

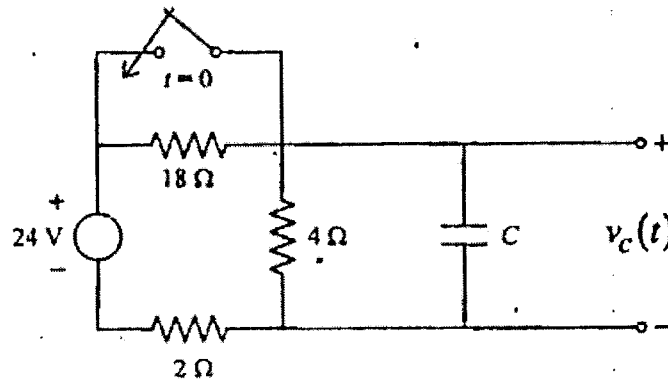

14. Define Transducer and classify them based on active and passive transducer.

A thermistor is to monitor room temperature. It has a resistance of $3.5\text{ k}\Omega$ at 20°C with a slope of $-10\%/^\circ\text{C}$. The dissipation constant is $P_D = 5\text{ mW}/^\circ\text{C}$. It is proposed to use the thermistor of figure given below to provide a voltage of 5.0 V at 20°C . Evaluate the effects of self heating.

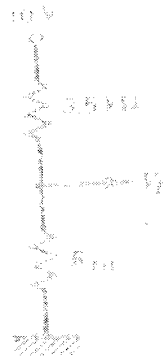

15. A plant with the transfer function $G(s)H(s) = \frac{900}{s(s+1)(s+9)}$ with a unity feedback is to be compensated such that the gain crossover frequency of the compensated system become same as the phase crossover frequency of the uncompensated system and has a phase margin of 45° . Suggest the suitable compensator and determine its transfer function.

16. An LTI system is described by

$$H(s) = \frac{1}{s^2 + 3s + 1}$$

Find the system response for the input

a. $x(t) = 2e^{-2t}$

b. $x(t) = 2 \cos(2t + 20^\circ)$.

17. Design a MOD-12 synchronous counter using D-Flip flop

18. Show that in a source free homogeneous isotropic linear medium, the time harmonic electric and magnetic fields are given by

$$E = -\nabla \times F + \frac{\nabla(\nabla \cdot A)}{j\omega\epsilon} - j\omega\mu A$$

$$H = \nabla \times A + \frac{\nabla(\nabla \cdot F)}{j\omega\epsilon} - j\omega\epsilon F$$

where A and F are magnetic and electric vector potential.

Section C

Attempt any 2 questions

19. A 3-phase, 7MVA, 11kV, star connected alternator is synchronized with an infinite bus at rated voltage. Now the steam input to machine set is increased till the synchronous machine begins to operate with a load angle of 40° . The synchronous machine has $Z_s = 0 + j12\Omega$. Calculate the power factor, armature current and the active and reactive powers delivered to infinite bus under these conditions. Without any change in steam input, how can this alternator be made to deliver zero reactive power to the bus? Calculate armature current, excitation voltage and load angle under these conditions. Draw phasor diagrams at time of synchronizing, when

a. Load angle is 40° ,

b. When no reactive power flows

20. A 20 MVA, 50 Hz generator delivers 18 MW over a double circuit line to an infinite bus. The generator has kinetic energy of 2.52 MJ/MVA at rated speed. The generator transient reactance is $X'_d = 0.35 pu$. Each transmission circuit has $R = 0$ and a reactance of 0.2 pu on a 20 MVA base. $|E'| = 1.1 pu$ and infinite bus voltage $V = 1.0 \angle 0^\circ$. A three-phase short circuit occurs at the midpoint of one of the transmission lines. Plot swing curves with fault cleared by simultaneous opening of breakers at both ends of the line at 2.5 cycles and 6.25 cycles after the occurrence of fault. Also, plot the swing curve over the period of 0.5 sec if the fault is sustained.
21. Sketch the Nyquist plot and examine the closed loop stability of a control system having open loop transfer function given below

$$G(s)H(s) = \frac{ks(1 + 2s)}{s^3 + 4s + 8}$$